

ГОСУДАРСТВЕННЫЙ СТАНДАРТ СОЮЗА ССР

ПРУЖИНЫ СЖАТИЯ

Конструкция и размеры

Compression springs.
Design and dimensions

ОКП 39 6330

Дата введения 1982-01-01

Постановлением Государственного комитета СССР по стандартам от 31 декабря 1980 г. N 6295 срок введения установлен с 01.01.82

ПРОВЕРЕН в 1985 г.

ВЗАМЕН ГОСТ 18793-73

ПЕРЕИЗДАНИЕ. Декабрь 1985 г.

1. Конструкция и размеры пружин сжатия должны соответствовать указанным на чертеже и в таблице.

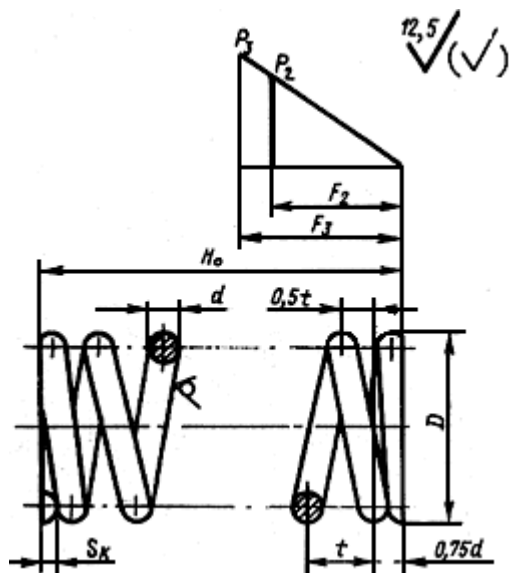

Размеры в мм



**ИЗГОТОВЛЕНИЕ ПРУЖИН
ПОД ЗАКАЗ ПО ЧЕРТЕЖАМ**

Телефон: +7(863)241-16-86

Email: dtm06@yandex.ru

Сайт: dtm06.ru

Обозначение пружины	Применяемость	Основные параметры витков		F_2 , Н (кгс)	F_3 , Н (кгс)	D	d	t	H_0	F_2	F_3^*	Число рабочих витков n	Число витков полное n_1	s_k , не менее	Длина развернутой пружины L	Масса, кг, не более
		Обозначение стандарта	Номер пружины													
1086-0751		ГОСТ 13771-68	95	5,00 (0,50)	6,30 (0,63)	3	0,36	1,05	5,8	2,75	3,44	5	7	0,09	59,1	0,0002
1086-0752	7,9								3,85	4,75	7	9	76,0			
1086-0753	11,1								5,50	6,89	10	12	101,4			
1086-0754	13,2								6,60	8,26	12	14	118,3			
1086-0755	15,2								7,70	9,65	14	16	135,2			
1086-0756		125	7,50 (0,75)	9,50 (0,95)	4	0,45	1,49	8,1	4,10	5,18	5	7	0,11	79,5	0,0001	
1086-0757	11,1							5,74	7,26	7	9	102,2				
1086-0758	15,5							8,20	10,37	10	12	136,3				
1086-0759	20,1							10,66	13,49	13	15	170,4		0,0002		
1086-0761		131	8,00 (0,80)	10,00 (1,00)	5	0,50	1,96	10,6	5,85	7,28	5	7	0,13	100,8	0,0001	
1086-0762	14,5							8,19	10,20	7	9	129,6		0,0002		
1086-0763	20,4							11,70	14,54	10	12	172,8		0,0003		
1066-0764	26,3							15,21	18,95	13	15	216,0				
1086-0765		162	11,20 (1,12)	14,00 (1,40)	6	0,60	2,30	10,1	5,44	6,80	4	6	0,15	103,7	0,0002	
1086-0766	14,7							8,16	10,21	6	8	138,2		0,0003		
1086-0767	23,9							13,60	17,01	10	12	207,4		0,0004		
1086-0768	30,8							17,68	22,11	13	15	259,2		0,0005		
1086-0769		208	20,00 (2,00)	25,00 (2,50)	8	0,80	3,08	16,6	9,10	11,39	5	7	0,20	161,3	0,0006	
1086-0771	22,8							12,74	15,95	7	9	207,4		0,0008		
1086-0772	32,0							18,20	22,78	10	12	276,5		0,0011		
1086-0773	41,2							23,66	29,95	13	15	345,6		0,0013		
1086-0774		240	30,00 (3,00)	37,50 (3,75)	10	1,00	3,73	16,4	8,76	10,93	4	6	0,25	172,8	0,0011	
1086-0775	23,9							13,14	16,40	6	8	230,4		0,0014		



ИЗГОТОВЛЕНИЕ ПРУЖИН
ПОД ЗАКАЗ ПО ЧЕРТЕЖАМ

Телефон: +7(863)241-16-86

Email: dtm06@yandex.ru

Сайт: dtm06.ru

1086-0776							35,1	19,71	24,60	9	11		316,8	0,0020
1086-0777							46,3	26,28	32,80	12	14		403,2	0,0026
1086-0778	271	42,50 (4,25)	53,00 (5,30)	11	1,20	3,61	16,2	7,72	9,63	4	6	0,30	188,2	0,0016
1086-0779							23,5	11,58	14,44	6	8		250,9	0,0022
1086-0781							30,7	15,44	19,27	8	10		313,6	0,0028
1086-0782							37,9	19,30	24,08	10	12		376,3	0,0034
1086-0783							45,1	23,16	28,89	12	14		439,0	0,0039
1086-0784							52,3	27,02	33,73	14	16		501,8	0,0045
1086-0785	307	63,00 (6,30)	80,00 (8,00)	17	1,60	6,06	26,6	14,04	17,83	4	6	0,40	295,7	0,0049
1086-0786							38,8	21,06	26,75	6	8		394,2	0,0061
1086-0787							50,9	28,08	35,67	8	10		492,8	0,0078
1086-0788							63,0	35,10	44,58	10	12		591,4	0,0094
1086-0789							75,1	42,12	53,51	12	14		689,9	0,0109
1086-0791	328	85,00 (8,50)	106,00 (10,60)	12		3,42	22,9	8,76	10,91	6	8		266,2	0,0043
1086-0792							29,8	11,68	14,55	8	10		332,8	0,0053
1086-0793							40,0	16,06	20,01	11	13		432,6	0,0069
1086-0794							50,3	20,44	25,46	14	16		532,5	0,0085
1086-0795							60,5	24,82	30,93	17	19		632,3	0,0100
1086-0796	342	100,00 (10,00)	125,00 (12,50)	15	1,80	4,54	34,5	15,33	19,17	7	9	0,45	380,2	0,0076
1086-0797							43,6	19,71	24,67	9	11		464,6	0,0093
1086-0798							52,6	24,09	30,12	11	13		549,1	0,0110
1086-0799							66,2	30,66	38,34	14	16		675,8	0,0136
1086-0801							79,9	37,23	46,57	17	19	0,50	802,6	0,0160
1086-0802	348	106,00 (10,60)	132,00 (13,20)	20	2,00	6,81	30,2	15,44	19,25	4	6		345,6	0,0085
1086-0803							43,8	23,16	28,87	6	8		460,8	0,0114
1086-0804							57,5	30,88	38,50	8	10		576,0	0,0143
1086-0805							71,0	38,60	48,12	10	12		691,2	0,0170
1086-0806							84,7	46,32	57,76	12	14		806,4	0,0199
1086-0807							98,3	54,04	67,38	14	16		921,6	0,0228
1086-0808	366	140,00	170,00	16		4,92	22,7	9,60	11,66	4	6		268,8	0,0065



СПЛАВ
ИЗГОТОВЛЕНИЕ ПРУЖИН
ПОД ЗАКАЗ ПО ЧЕРТЕЖАМ

Телефон: +7(863)241-16-86

Email: dtm06@yandex.ru

Сайт: dtm06.ru

1086-0809														
1086-0811														
1086-0812														
1086-0813														
1086-0814														
1086-0815														
1086-0816	375	150,00 (15,00)	190,00 (19,00)	18	2,20	5,40	35,7	15,12	19,18	6	8	0,55	404,5	0,0120
1086-0817							46,5	20,16	25,57	8	10		505,6	0,0151
1086-0818							57,3	25,20	31,96	10	12		606,7	0,0181
1086-0819							78,9	35,28	44,49	14	16		809,0	0,0247
1086-0821							89,7	40,32	51,11	16	18		910,1	0,0272
1086-0822	397	190,00 (19,00)	236,00 (23,60)	20	2,50	5,74	32,5	13,05	16,18	5	7	0,63	392,0	0,0157
1086-0823							44,0	18,27	22,66	7	9		504,0	0,0190
1086-0824							61,2	26,10	32,37	10	12		672,0	0,0258
1086-0825							72,7	31,32	38,85	12	14		784,0	0,0301
1086-0826							84,2	36,54	45,33	14	16		896,0	0,0344
1086-0827							95,6	41,76	51,81	16	18		1008,0	0,0392
1086-0828	423	250,00 (25,00)	315,00 (31,50)	25	3,00	7,14	33,1	13,16	16,55	4	6	0,75	422,4	0,0234
1086-0829							47,3	19,74	24,84	6	8		563,2	0,0313
1086-0831							61,6	26,32	33,13	8	10		704,0	0,0390
1086-0832							83,0	36,19	45,55	11	13		915,2	0,0507
1086-0833							104,5	46,06	57,96	14	16		1126,4	0,0630
1086-0834							118,7	52,64	66,26	16	18		1267,2	0,0708
1086-0835	441	315,00 (31,50)	400,00 (40,00)	20		5,43	31,7	9,55	12,15	5	7		380,8	0,0212
1086-0836							42,5	13,37	17,01	7	9		489,6	0,0272
1086-0837							58,8	19,10	24,30	10	12		652,8	0,0362
1086-0838							75,1	24,83	31,59	13	15		816,0	0,0453
1086-0839	441	315,00 (31,50)	400,00 (40,00)	20		5,43	86,0	28,65	36,45	15	17		924,8	0,0513
1086-0841							102,2	34,38	43,74	18	20		1088,0	0,0608
1086-0842	447	335,00	425,00	28	3,50	7,67	28,3	9,84	12,50	3	5	0,88	392,0	0,0299



ИЗГОТОВЛЕНИЕ ПРУЖИН
ПОД ЗАКАЗ ПО ЧЕРТЕЖАМ

Телефон: +7(863)241-16-86

Email: dtm06@yandex.ru

Сайт: dtm06.ru

1086-0843			(33,50)	(42,50)				36,0	13,12	16,66	4	6		470,4	0,0352
1086-0844								43,7	16,40	21,32	5	7		548,8	0,0416
1086-0845								51,3	19,68	25,00	6	8		627,2	0,0475
1086-0846								66,7	26,24	33,33	8	10		784,0	0,0593
1086-0847								89,7	36,08	45,83	11	13		1019,2	0,0769
1086-0848								105,0	42,64	54,16	13	15		1176,0	0,0892
1086-0849								120,3	49,20	62,50	15	17		1332,8	0,1010
1086-0851								135,7	55,76	70,83	17	19		1489,6	0,1127
1086-0852	462	400,00 (40,00)	500,00 (50,00)	24		6,38		37,2	11,50	14,37	5	7		459,2	0,0344
1086-0853								50,0	16,10	20,12	7	9		590,4	0,0448
1086-0854								62,8	20,70	25,87	9	11		712,6	0,0541
1086-0855								75,5	25,30	31,62	11	13		852,8	0,0639
1086-0856								88,2	29,90	37,37	13	15		984,0	0,0743
1086-0857								101,0	34,50	43,12	15	17		1115,2	0,0906
1086-0858								113,7	39,10	48,88	17	19		1246,4	0,0944
1086-0859								126,5	43,70	54,63	19	21		1377,6	0,1018
1086-0861	463				36	4,00	10,40	37,2	15,36	19,20	3	5	1,00	512,0	0,0503
1086-0862								58,0	25,60	32,00	5	7		716,8	0,0711
1086-0863								68,4	30,72	38,40	6	8		819,2	0,0806
1086-0864								99,6	46,08	57,60	9	11		1126,4	0,1113
1086-0865								130,8	61,44	76,80	12	14		1433,6	0,1416
1086-0866								162,0	76,80	96,06	15	17		1740,8	0,1725
1086-0867								182,8	87,04	108,83	17	19		1945,6	0,1925
1066-0868	467	425,00 (42,50)	530,00 (53,00)	22	3,50	5,74		39,7	10,74	13,41	6	8	0,88	473,6	0,0355
1086-0869								51,2	14,32	17,88	8	10		592,0	0,0449
1086-0871								62,7	17,90	22,36	10	12		710,4	0,0533
1086-0872								74,2	21,48	26,83	12	14		828,8	0,0627
1086-0873								91,4	26,85	33,54	15	17		1006,4	0,0760
1086-0874								102,8	30,43	38,01	17	19		1124,7	0,0854
1086-0875								114,3	34,01	42,48	19	21		1243,2	0,0942



ИЗГОТОВЛЕНИЕ ПРУЖИН
ПОД ЗАКАЗ ПО ЧЕРТЕЖАМ

Телефон: +7(863)241-16-86

Email: dtm06@yandex.ru

Сайт: dtm06.ru

1086-0876		480	500,00 (50,00)	630,00 (63,00)	28	4,00	7,40	43,0	13,50	17,00	5	7	1,00	537,6	0,0529
1086-0877								57,8	18,90	23,81	7	9		691,2	0,0681
1086-0878								72,6	24,30	30,61	9	11		844,8	0,0832
1086-0879								87,4	29,70	37,42	11	13		998,4	0,0983
1086-0881								102,2	35,10	44,22	13	15		1152,0	0,1139
1086-0882								117,0	40,50	51,02	15	17		1305,6	0,1290
1086-0883								131,8	45,90	57,83	17	19		1459,2	0,1441
1086-0884		488	560,00 (56,00)	710,00 (71,00)	25	4,00	6,57	45,4	12,18	15,41	6	8		537,6	0,0529
1086-0885								58,6	16,24	20,54	8	10		672,0	0,0662
1086-0886								71,7	20,30	25,68	10	12		806,4	0,0794
1086-0887								84,8	24,36	30,82	12	14		940,8	0,0926
1086-0888								104,5	30,45	38,53	15	17		1142,4	0,1130
1086-0889								117,7	34,51	43,67	17	19		1276,8	0,1262
1086-0891	ГОСТ 13772-68	66	710,00 (71,00)	900,00 (90,00)	38	4,50	12,73	45,0	19,50	24,70	3	5	1,13	536,0	0,0668
1086-0892								70,5	32,50	41,17	5	7		750,4	0,0936
1086-0893								95,9	45,50	57,64	7	9		964,8	0,1210
1086-0894								121,4	58,50	74,11	9	11		1179,2	0,1528
1086-0895								146,8	71,50	90,57	11	13		1393,6	0,1795
1086-0896								172,3	84,50	107,04	13	15		1608,0	0,2064
1086-0897								197,8	97,50	123,51	15	17		1822,4	0,2331
1086-0898		75	800,00 (80,00)	1000,00 (100,00)	34	4,50	10,76	39,1	15,03	18,78	3	5		472,0	0,0589
1086-0899								49,8	20,04	25,04	4	6		566,4	0,0713
1086-0901								60,6	25,05	31,30	5	7		660,8	0,0826
1086-0902								71,4	30,06	37,57	6	8		755,2	0,0948
1086-0903								82,1	35,07	43,83	7	9		849,6	0,1061
1086-0904								103,6	45,09	56,35	9	11		1038,4	0,1303
1086-0905								125,2	55,11	68,94	11	13		1227,2	0,1588
1086-0906								146,7	65,13	81,40	13	15		1416,0	0,1824
1086-0907								168,2	75,15	93,93	15	17		1604,8	0,2061
1086-0908		89	950,00	1180,00	28		8,23	39,7	12,00	14,91	4	6		451,2	0,0564



ИЗГОТОВЛЕНИЕ ПРУЖИН
ПОД ЗАКАЗ ПО ЧЕРТЕЖАМ

Телефон: +7(863)241-16-86

Email: dtm06@yandex.ru

Сайт: dtm06.ru

1086-0909		(95,00)	(118,00)				47,9	15,00	18,64	5	7		526,4	0,0657
1086-0911							64,4	21,00	26,10	7	9		676,8	0,0846
1086-0912							80,9	27,00	33,56	9	11		827,2	0,1045
1086-0913							97,3	33,00	41,02	11	13		971,6	0,1226
1086-0914							113,8	39,00	48,48	13	15		1128,0	0,1460
1086-0915							138,5	48,00	59,67	16	18		1353,6	0,1747
1086-0916	90			38	5,00	11,79	42,9	16,38	20,35	3	5	1,25	528,0	0,0787
1086-0917							54,7	21,84	27,16	4	6		633,6	0,0973
1086-0918							66,5	27,30	33,92	5	7		739,2	0,1132
1086-0919							77,9	32,76	40,71	6	8		844,8	0,1301
1086-0921							101,8	43,68	54,28	8	10		1056,0	0,1584
1086-0922							125,5	54,60	67,85	10	12		1267,2	0,1892
1086-0923							149,0	65,52	81,42	12	14		1478,4	0,2239
1086-0924							172,5	76,44	95,00	14	16		1689,6	0,2555
1086-0925							196,1	87,36	108,57	16	18		1900,8	0,2883
1086-0926	94	1000,00 (100,00)	1250,00 (125,00)	36		10,96	51,3	19,08	23,83	4	6		595,2	0,0915
1086-0927							73,3	28,62	35,74	6	8		793,6	0,1223
1086-0928							95,2	38,16	47,66	8	10		992,0	0,1531
1086-0929							117,1	47,70	59,58	10	12		1190,4	0,1788
1086-0931							140,0	57,24	72,07	12	14		1386,8	0,2095
1086-0932							160,9	66,78	83,35	14	16		1587,2	0,2403
1086-0933							182,9	76,32	95,33	16	18		1785,6	0,2710
1086-0934	103	1120,00 (112,00)	1400,00 (140,00)	32	5,00	9,41	54,5	17,65	22,04	5	7		604,8	0,0930
1086-0935							73,4	24,71	30,86	7	9		777,6	0,1198
1086-0936							92,2	31,77	39,68	9	11		950,4	0,1466
1086-0937							111,0	38,83	48,88	11	13		1123,2	0,1688
1086-0938							129,8	45,89	57,32	13	15		1296,0	0,1956
1086-0939							148,7	52,95	66,14	15	17		1468,8	0,2225
1086-0941							167,5	60,01	74,95	17	19		1641,6	0,2487
1086-0942	104			42	5,50	12,94	47,1	17,85	22,31	3	5	138	584,0	0,1094



ИЗГОТОВЛЕНИЕ ПРУЖИН
ПОД ЗАКАЗ ПО ЧЕРТЕЖАМ

Телефон: +7(863)241-16-86

Email: dtm06@yandex.ru

Сайт: dtm06.ru

1086-0943							60,1	23,80	29,74	4	6		700,8	0,1305
1086-0944							85,9	35,70	44,63	6	8		934,4	0,1748
1086-0945							111,8	47,60	59,51	8	10		1168,0	0,2214
1086-0946							137,7	59,50	74,33	10	12		1407,8	0,2647
1086-0947							163,6	71,40	89,26	12	14		1635,2	0,3090
1086-0048							189,5	83,30	104,15	14	16		1868,8	0,3526
1086-0949							215,3	95,20	119,87	16	18		2102,4	0,3889
1086-0951	112	1250,00 (125,00)	1600,00 (160,00)	28	5,00	8,12	56,2	14,58	18,68	6	8	1,25	588,8	0,0905
1086-0952							72,5	19,44	24,91	8	10		736,0	0,1127
1086-0953							88,7	24,30	31,14	10	12		883,2	0,1357
1086-0954							104,9	29,16	37,37	12	14		1030,4	0,1589
1086-0955							121,2	34,02	43,60	14	16		1177,6	0,1768
1086-0956							137,4	38,88	49,83	16	18		1324,8	0,2001
1086-0957	113			38	5,50	11,50	54,3	18,76	24,00	4	6	1,38	624,0	0,1170
1086-0958							65,8	23,45	30,00	5	7		728,0	0,1357
1086-0959							77,3	28,14	36,25	6	8		832,0	0,1555
1086-0961							100,3	37,52	48,01	8	10		1040,0	0,1940
1086-0962							123,3	46,90	60,00	10	12		1248,0	0,2364
1086-0963							146,3	56,28	72,02	12	14		1456,0	0,2753
1086-0964							169,3	65,66	84,02	14	16		1664,0	0,3138
1086-0965							192,3	75,04	96,02	16	18		1872,0	0,3532
1086-0966	122	1400,00 (140,00)	1800,00 (180,00)	34		10,06	38,5	10,62	13,66	3	5		456,0	0,0853
1086-0967							58,6	17,70	22,77	5	7		638,4	0,1196
1086-0968							78,7	24,78	31,88	7	9		820,8	0,1534
1086-0969							98,8	31,86	40,99	9	11		1003,2	0,1871
1086-0971							119,0	38,94	50,09	11	13		1185,6	0,2248
1086-0972							139,1	46,02	59,21	13	15		1368,0	0,2584
1086-0973							159,2	53,10	68,32	15	17		1550,4	0,2932
1086-0974							179,3	60,18	77,42	17	19		1732,8	0,3266
1086-0975							199,4	67,26	86,53	19	21		1915,2	0,3613



ИЗГОТОВЛЕНИЕ ПРУЖИН
ПОД ЗАКАЗ ПО ЧЕРТЕЖАМ

Телефон: +7(863)241-16-86

Email: dtm06@yandex.ru

Сайт: dtm06.ru

1086-0976									219,5	74,34	95,64	21	23		2097,6	0,3881
1086-0977		123		42	6,00	12,48			46,4	15,12	19,43	3	5	1,50	576,0	0,1284
1086-0978									71,4	25,20	32,39	5	7		806,4	0,1784
1086-0979									96,4	35,28	45,35	7	9		1036,8	0,2300
1086-0981									121,3	45,36	58,31	9	1,1		1267,2	0,2786
1086-0982									146,3	55,44	71,27	11	13		1497,6	0,3304
1086-0983									171,2	65,52	84,23	13	15		1728,0	0,3811
1086-0984									196,2	75,60	97,19	15	17		1958,4	0,4327
1086-0985		121	1500,00 (150,00)	25	5,00	7,30			58,6	13,44	16,12	7	9	1,25	576,0	0,0886
1086-0986									73,2	17,28	20,73	9	11		704,0	0,1077
1086-0987									80,5	19,20	23,04	10	12		768,0	0,1183
1086-0988									95,1	23,04	27,64	12	14		896,0	0,1377
1086-0989									109,7	26,88	30,46	14	16		1024,0	0,1580
1086-0991									124,3	30,72	36,86	16	18		1152,0	0,1729

Продолжение таблицы

Размеры в мм

Обозначение пружины	Применяемость	Основные параметры витков		F_2 , Н (кгс)	F_3 , Н (кгс)	D	d	t	H_0	F_2	F_3^*	Число рабочих витков n	Число витков полное n_1	s_k , не менее	Длина развинутой пружины L	Масса, кг, не более
		Обозначение стандарта	Номер пружины													
1086-0992		ГОСТ 13772-68	130	1600,00 (160,00)	2000,00 (200,00)	30	5,50	8,71	60,6	15,42	19,28	6	8	1,38	627,2	0,1176
1086-0993									78,0	20,56	25,70	8	10		784,0	0,1465
1086-0994									95,4	25,70	32,13	10	12		940,8	0,1754
1086-0995									112,8	30,84	38,55	12	14		1097,6	0,2081
1086-0996									130,2	35,98	44,98	14	16		1254,6	0,2370
1086-0997									147,7	41,12	51,41	16	18		1411,2	0,2666
1086-0998									139	1800,00	2240,00	34	6,00		9,80	58,0



ИЗГОТОВЛЕНИЕ ПРУЖИН
ПОД ЗАКАЗ ПО ЧЕРТЕЖАМ

Телефон: +7(863)241-16-86

Email: dtm06@yandex.ru

Сайт: dtm06.ru

		(180,00)	(224,00)											
1086-0999														
1086-1001							67,8	18,30	22,76	6	8		716,8	0,1587
1086-1002							77,6	21,35	26,55	7	9		806,4	0,1783
1086-1003							97,2	27,45	34,14	9	11		985,6	0,2188
1086-1004							116,8	33,55	41,73	11	13		1164,8	0,2561
1086-1005							136,4	39,65	49,32	13	15		1344,0	0,2927
1086-1006							156,0	45,75	56,91	15	17		1523,2	0,3361
1086-1007							175,6	51,85	64,49	17	19		1702,4	0,3755
1086-1007	140			52	7,00	15,50	57,0	20,49	25,51	3	5	1,75	720,0	0,2167
1086-1008							72,5	27,32	34,01	4	6		864,0	0,2600
1086-1009							88,0	34,15	42,51	5	7		1008,0	0,3041
1086-1011							103,5	40,98	51,02	6	8		1152,0	0,3454
1086-1012							134,5	54,64	68,03	8	10		1440,0	0,4327
1086-1013							165,5	68,30	85,04	10	12		1728,0	0,5191
1086-1014							196,5	81,96	102,05	12	14		2016,0	0,6065
1086-1015							227,5	95,62	119,06	14	16		2304,0	0,6909
1086-1016							258,5	109,28	136,07	16	18		2592,0	0,7782
1086-1017	148	2000,00 (200,00)	2500,00 (250,00)	48			53,1	17,25	21,56	3	5		556,0	0,1977
1086-1018							67,3	23,00	28,74	4	6		787,2	0,2369
1086-1019							81,5	28,75	35,92	5	7		918,4	0,2779
1086-1021							95,6	34,50	43,11	6	8		1049,6	0,3168
1086-1022							124,0	46,00	57,48	8	10		1312,0	0,3934
1086-1023							152,4	57,50	71,81	10	12		1574,4	0,4730
1086-1024							180,8	69,00	86,41	12	14		1836,8	0,5519
1086-1025							209,2	80,50	100,60	14	16		2099,8	0,6296
1086-1026							237,5	92,00	114,98	16	18		2361,6	0,7084
1086-1027	151	2120,00 (212,00)	2650,00 (265,00)	45		13,06	49,7	14,52	18,16	3	5		608,0	0,1832
1086-1028							62,7	19,36	24,23	4	6		729,6	0,2196
1086-1029							75,8	24,20	30,27	5	7		851,2	0,2562
1086-1031							88,9	29,04	36,33	6	8		972,8	0,2935
1086-1032							101,9	33,88	42,38	7	9		1094,4	0,3281



ИЗГОТОВЛЕНИЕ ПРУЖИН
ПОД ЗАКАЗ ПО ЧЕРТЕЖАМ

Телефон: +7(863)241-16-86

Email: dtm06@yandex.ru

Сайт: dtm06.ru

Код	Объем	Цена	Цена	Цена	Цена	Толщина	Среднее	Среднее	Среднее	Среднее	Среднее	Среднее	Среднее		
1086-1033															
1086-1034															
1086-1035															
1086-1036															
1086-1037															
1086-1038															
1086-1039															
1086-1041															
1086-1042	155	2240,00 (224,00)	2800,00 (280,00)	42			12,00	46,5	12,00	15,00	3	5	560,0	0,1687	
1086-1043								70,5	20,00	25,00	5	7	784,0	0,2360	
1086-1044								94,5	28,00	35,00	7	9	1008,0	0,3042	
1086-1045								118,5	36,00	45,00	9	11	1232,0	0,3695	
1086-1046								142,5	44,00	55,00	11	13	1456,0	0,4375	
1086-1047								166,5	52,00	65,01	13	15	1680,0	0,5047	
1086-1048								178,5	56,00	70,00	14	16	1792,0	0,5384	
1086-1049								202,5	64,00	80,00	16	18	2016,0	0,6066	
1086-1051	164	2500,00 (250,00)	3150,00 (315,00)	55	8,00		15,98	60,0	19,02	23,95	3	5	2,00	752,0	0,2963
1086-1052								75,9	25,36	31,93	4	6	902,4	0,3558	
1086-1053								107,9	38,04	47,90	6	8	1203,2	0,4801	
1086-1054								139,8	50,72	63,87	8	10	1504,0	0,5981	
1086-1055								171,8	63,40	79,84	10	12	1804,8	0,7175	
1086-1056								203,8	76,08	95,81	12	14	2105,6	0,8315	
1086-1057								235,7	88,76	111,58	14	16	2406,4	0,9503	
1086-1058								267,7	101,44	127,75	16	18	2707,2	1,0686	
1086-1059	172	2800,00 (260,00)	3550,00 (355,00)	50			14,42	55,3	15,18	19,26	3	5	672,0	0,2648	
1086-1061								69,7	20,24	25,68	4	6	806,4	0,3184	
1086-1062								98,5	30,36	38,52	6	8	1075,2	0,4291	
1086-1063								127,4	40,48	51,36	8	10	1344,0	0,5352	
1086-1064								156,2	50,60	64,20	10	12	1612,8	0,6415	
1086-1065								185,0	60,72	77,04	12	14	1881,6	0,7476	



ИЗГОТОВЛЕНИЕ ПРУЖИН
ПОД ЗАКАЗ ПО ЧЕРТЕЖАМ

Телефон: +7(863)241-16-86

Email: dtm06@yandex.ru

Сайт: dtm06.ru

1086-1066							213,9	70,84	89,89	14	16		2150,4	0,8488
1086-1067							242,7	80,96	102,73	16	18		2419,2	0,9594
1086-1068	173			70	9,00	21,30	77,4	29,10	36,88	3	5	2,25	976,0	0,4857
1086-1069							98,7	38,80	49,18	4	6		1171,2	0,5843
1086-1071							120,0	48,50	61,48	5	7		1366,4	0,6819
1086-1072							162,6	67,90	83,65	7	9		1756,8	0,8761
1086-1073							183,9	77,60	98,37	8	10		1952,0	0,9737
1086-1074							226,5	97,00	122,96	10	12		2342,4	1,1700
1086-1075							269,1	116,40	147,56	12	14		2732,8	1,3642
1086-1076							311,7	135,80	172,15	14	16		3123,2	1,5604
1086-1077							354,3	155,20	196,75	16	18		3513,6	1,7556
1086-1078	176	3000,00 (300,00)	3750,00 (375,00)	48	8,00	13,86	53,6	14,07	17,57	3	5	2,00	640,0	0,2527
1086-1079							81,3	23,45	29,29	5	7		896,0	0,3533
1086-1081							109,0	32,83	41,01	7	9		1152,0	0,4595
1086-1082							150,6	46,90	58,58	10	12		1536,0	0,6111
1086-1083							178,3	56,28	70,31	12	14		1792,0	0,7128
1086-1084							206,0	65,66	82,03	14	16		2048,0	0,8139
1086-1085							233,8	75,04	93,75	16	18		2304,0	0,9095
1086-1086							261,5	84,42	105,48	18	20		2560,0	1,0106
1086-1087							289,2	93,80	117,19	20	22		2816,0	1,1122
1086-1088							316,9	103,18	128,91	22	24		3072,0	1,2179
1086-1089							344,6	112,60	140,66	24	26		3328,0	1,3190
1086-1091	182	3150,00 (315,00)	4000,00 (400,00)	63	9,00	18,60	69,3	22,68	28,57	3	5	2,25	864,0	0,4298
1086-1092							87,9	30,24	38,39	4	6		1036,8	0,5163
1086-1093							125,1	45,36	57,56	6	8		1382,4	0,6900
1086-1094							162,3	60,48	76,79	8	10		1728,0	0,8619
1086-1095							199,5	75,60	95,99	10	12		2073,6	1,0348
1086-1096							236,7	90,72	115,19	12	14		2419,2	1,2085
1086-1097							273,9	105,84	134,45	14	16		2764,8	1,3802
1086-1098							311,1	120,96	153,59	16	18		3110,4	1,5541



**ИЗГОТОВЛЕНИЕ ПРУЖИН
ПОД ЗАКАЗ ПО ЧЕРТЕЖАМ**

Телефон: +7(863)241-16-86

Email: dtm06@yandex.ru

Сайт: dtm06.ru

1086-1099													
1086-1101	187	3350,00 (335,00)	4250,00 (425,00)	60		17,60	348,3	136,08	172,78	18	20	3456,0	1,7268
1086-1102							66,3	20,31	25,77	3	5	816,0	0,4060
1086-1103							83,9	27,08	34,37	4	6	979,2	0,4875
1086-1104							101,5	33,85	42,96	5	7	1142,4	0,5701
1086-1105							136,7	47,39	60,14	7	9	1468,8	0,7333
1086-1106							171,9	60,93	77,29	9	11	1795,2	0,8956
1086-1107							207,1	74,47	94,52	11	13	2121,6	1,0598
1086-1108							242,3	88,01	111,70	13	15	2448,0	1,2229
1086-1109							277,5	101,55	128,89	15	17	2774,4	1,3831
1086-1111	192		4500,00 (450,00)	55		15,67	312,7	115,09	146,07	17	19	3100,8	1,5494
1086-1112							60,5	15,78	20,01	3	5	736,0	0,3660
1086-1113							91,9	26,30	33,35	5	7	1030,4	0,5132
1086-1114							138,9	42,08	53,37	8	10	1472,0	0,7350
1086-1115							185,9	57,86	73,23	11	13	1913,6	0,9540
1086-1116							217,2	68,38	86,70	13	15	2208,0	1,1031
1086-1117							248,5	78,90	100,07	15	17	2502,4	1,2503
1086-1118							279,9	89,42	113,41	17	19	2796,8	1,3965
1086-1119							326,9	105,20	133,43	20	22	3238,4	1,6182
1086-1121							373,9	120,98	153,44	23	25	3680,0	1,8379
1086-1122	200	4000,00 (400,00)	5000,00 (500,00)	50	9,00	14,25	405,3	131,50	166,78	25	27	3974,4	1,9853
1086-1123							99,0	25,20	31,51	6	8	1049,6	0,5229
1086-1124							127,5	33,60	42,02	8	10	1312,0	0,6552
1086-1125							156,0	42,00	52,52	10	12	1574,4	0,7864
1086-1126							184,5	50,40	63,03	12	14	1836,8	0,9165
1086-1127							212,5	58,80	73,53	14	16	2099,2	1,0488
1086-1128							241,5	67,20	84,04	16	18	2361,6	1,1799
1086-1129	201			70	10,00	20,80	270,0	75,60	94,54	18	20	2624,0	1,3111
1086-1131							77,4	25,92	32,39	3	5	960,0	0,5913
1086-1132							98,2	34,56	42,33	4	6	1152,0	0,7124
							119,0	43,20	53,98	5	7	1344,0	0,8304



ИЗГОТОВЛЕНИЕ ПРУЖИН
ПОД ЗАКАЗ ПО ЧЕРТЕЖАМ

Телефон: +7(863)241-16-86

Email: dtm06@yandex.ru

Сайт: dtm06.ru

1086-1133							160,6	60,48	75,59	7	9		1728,0	1,0675
1086-1134							181,4	69,12	86,39	8	10		1920,0	1,1866
1086-1135							223,0	86,40	107,98	10	12		2304,0	1,4158
1086-1136							264,6	103,68	129,59	12	14		2688,0	1,6536
1086-1137							306,2	120,96	151,18	14	16		3072,0	1,8897
1086-1138							347,8	138,24	172,78	16	18		3456,0	2,1298
1086-1139	208	4500,00 (450,00)	5600,00 (560,00)	45	9,00	12,98	104,4	22,40	27,87	7	9	2,25	1036,8	0,5166
1086-1141							130,3	28,80	35,84	9	11		1267,2	0,6329
1086-1142							156,3	35,20	43,81	11	13		1497,6	0,7481
1086-1143							182,3	41,60	51,77	13	15		1728,0	0,8622
1086-1144							208,2	48,00	59,74	15	17		1958,4	0,9775
1086-1145							234,2	54,40	67,71	17	19		2188,8	1,0937
1086-1146	209			63	10,00	18,34	88,4	26,80	33,34	4	6	2,50	1017,6	0,6262
1086-1147							106,7	33,50	41,68	5	7		1187,2	0,7342
1086-1148							143,4	46,90	58,35	7	9		1526,4	0,9437
1086-1149							180,0	60,30	75,03	9	11		1865,6	1,1529
1086-1151							216,7	73,70	91,70	11	13		2204,8	1,3553
1086-1152							253,4	87,10	108,38	13	15		2544,0	1,5645
1086-1153							290,1	100,50	125,05	15	17		2883,2	1,7737
1086-1154							326,8	113,90	141,72	17	19		3222,4	1,9862
1086-1155	210			85	11,00	26,52	96,1	37,41	46,55	3	5	2,75	1184,0	0,8851
1086-1156							122,6	49,88	62,06	4	6		1420,8	1,0615
1086-1157							149,1	62,35	77,58	5	7		1657,6	1,2384
1086-1158							175,6	74,82	93,10	6	8		1894,4	1,4149
1086-1159							202,1	87,29	108,61	7	9		2131,2	1,5858
1086-1161							228,7	99,76	124,12	8	10		2368,0	1,7622
1086-1162							255,2	112,23	139,62	9	11		2604,8	1,9387
1086-1163							281,7	124,70	155,16	10	12		2841,6	2,1155
1086-1164							334,7	149,64	186,04	12	14		3315,2	2,4734
1086-1165							387,8	174,58	217,05	14	16		3788,2	2,8267



**ИЗГОТОВЛЕНИЕ ПРУЖИН
ПОД ЗАКАЗ ПО ЧЕРТЕЖАМ**

Телефон: +7(863)241-16-86

Email: dtm06@yandex.ru

Сайт: dtm06.ru

1086-1166																			
1086-1167		219	5300,00 (530,00)	6700,00 (670,00)	70		20,40	440,8	199,52	248,27	16	18			4262,4	3,1740			
1086-1168								77,7	22,32	28,19	3	5			944,0	0,7028			
1086-1169								98,1	29,76	37,58	4	6			1132,8	0,8474			
1086-1171								118,5	37,20	46,98	5	7			1321,6	0,9880			
1086-1172								159,3	52,08	65,79	7	9			1699,2	1,2704			
1086-1173								200,1	66,96	84,59	9	11			2076,8	1,5540			
1086-1174								240,9	81,84	103,38	11	13			2454,4	1,8276			
1086-1175								281,7	96,72	122,17	13	15			2832,0	2,1088			
1086-1176								322,5	111,60	140,97	15	17			3209,6	2,3951			
1086-1177		226	6300,00 (630,00)	8000,00 (800,00)	60		17,41	363,3	126,48	159,77	17	19			3587,2	2,6760			
1086-1178								86,1	20,20	25,64	4	6			940,8	0,7007			
1086-1179								121,0	30,30	38,46	6	8			1254,4	0,9388			
1086-1181								155,8	40,40	51,27	8	10			1568,0	1,1719			
1086-1182								190,6	50,50	64,10	10	12			1881,6	1,4062			
1086-1183								225,4	60,60	76,92	12	14			2195,2	1,6345			
1086-1184								260,2	70,70	89,74	14	16			2508,8	1,8678			
1086-1185		229	6700,00 (670,00)	8500,00 (850,00)	70	12,00	20,00	295,1	80,80	102,56	16	18			2822,4	2,1019			
1086-1186								98,0	25,20	31,92	4	6	3,00		1113,6	0,9889			
1086-1187								138,0	37,80	47,97	6	8			1484,8	1,3181			
1086-1188								158,0	44,10	55,97	7	9			1670,4	1,4833			
1086-1189								178,0	50,40	63,96	8	10			1856,0	1,6485			
1086-1191								198,0	56,70	71,97	9	11			2041,6	1,8127			
1086-1192								218,0	63,00	79,96	10	12			2227,2	1,9800			
1086-1193								258,0	75,60	95,95	12	14			2598,4	2,3085			
1086-1194								298,0	88,20	111,94	14	16			2969,6	2,6386			
1086-1195								338,0	100,80	127,93	16	18			3340,8	2,9610			
1086-1196	ГОСТ 13773-68	25	7100,00 (710,00)	9000,00 (900,00)	90	14,00	24,28	378,0	113,40	143,93	18	20			3712,0	3,2904			
1086-1197								93,8	24,33	30,85	3	5	3,50		1216,0	1,4676			
1086-1198								118,1	32,44	41,13	4	6			1459,6	1,7609			
								142,4	40,55	51,42	5	7			1702,4	2,0551			



ИЗГОТОВЛЕНИЕ ПРУЖИН
ПОД ЗАКАЗ ПО ЧЕРТЕЖАМ

Телефон: +7(863)241-16-86

Email: dtm06@yandex.ru

Сайт: dtm06.ru

1086-1199									166,7	48,66	61,70	6	8		1945,6	2,3485
1086-1201									191,0	56,77	72,00	7	9		2188,8	2,6446
1086-1202									215,2	64,88	82,27	8	10		2432,0	2,9631
1086-1203									239,5	72,99	92,59	9	11		2675,2	3,2322
1086-1204									288,0	89,21	113,13	11	13		3161,6	3,8118
1086-1205									336,6	105,43	133,69	13	15		3648,0	4,3994
1086-1206									385,2	121,65	154,26	16	17		4134,4	4,9980
1086-1207									433,8	137,87	174,82	17	19		4620,8	5,5763
1086-1208	ГОСТ 13772-68	232	8000,00 (800,00)	10000,00 (1000,00)	60	12,00	17,33	104,7	21,35	26,66	5	7	3,00	1075,2	0,9530	
1086-1209								122,0	25,62	32,00	6	8		1228,8	1,0918	
1086-1211								156,6	34,16	42,66	8	10		1536,0	1,3642	
1086-1212								191,3	42,70	53,33	10	12		1843,2	1,6376	
1086-1213								226,0	51,24	64,00	12	14		2150,4	1,9119	
1086-1214								260,7	59,78	74,66	14	16		2457,6	2,1843	
1086-1215								295,3	68,32	85,33	16	18		2764,8	2,4577	
1086-1216	ГОСТ 13773-68	46	9500,00 (950,00)	11800,00 (1180,00)	100	16,00	26,61	130,4	34,16	42,44	4	6	4,00	1612,8	2,5418	
1086-1217								157,0	42,70	53,10	5	7		1881,6	2,9666	
1086-1218								183,7	51,24	63,68	6	8		2150,4	3,3923	
1086-1219								210,3	59,78	74,27	7	9		2419,2	3,8170	
1086-1221								236,9	68,32	84,89	8	10		2688,0	4,2406	
1086-1222								263,5	76,86	95,52	9	11		2956,8	4,6644	
1086-1223								290,1	85,40	106,11	10	12		3225,6	5,0810	
1086-1224								343,3	102,48	127,33	12	14		3763,2	5,9296	
1086-1225								396,5	119,56	148,55	14	16		4300,8	6,7798	
1986-1226								449,8	136,64	169,78	16	18		4838,4	7,6281	
1086-1227								503,0	153,72	191,09	18	20		5376,0	8,4787	
1086-1228		63	11800,00 (1180,00)	15000,00 (1500,00)	80		22,00	134,0	23,60	30,00	5	7		1433,8	2,2600	
1086-1229								178,0	33,04	42,00	7	9		1843,2	2,9072	
1086-1231								222,0	42,48	53,99	9	11		2252,8	3,5553	
1086-1232								266,0	51,92	66,00	11	13		2662,4	4,2015	



**ИЗГОТОВЛЕНИЕ ПРУЖИН
ПОД ЗАКАЗ ПО ЧЕРТЕЖАМ**

Телефон: +7(863)241-16-86

Email: dtm06@yandex.ru

Сайт: dtm06.ru

1086-1233							310,0	61,36	77,99	13	15		3072,0	4,8476
1086-1234							354,0	70,80	89,99	15	17		3481,6	5,4858
1086-1235							398,0	80,24	101,99	17	19		3891,2	6,1330
1086-1236	76	15000,00 (1500,00)	18000,00 (1800,00)	95	18,00	25,84	156,2	32,65	39,19	5	7	4,50	1724,8	3,4433
1086-1237							207,9	45,71	54,87	7	9		2217,6	4,4288
1086-1238							259,6	58,77	70,58	9	11		2710,4	5,4134
1086-1239							311,2	71,83	86,23	11	13		3203,2	6,3900
1086-1241							362,9	84,89	101,92	13	15		3696,0	7,3747
1086-1242							414,6	97,95	117,57	15	17		4188,8	8,3613
1086-1243							466,3	110,00	133,27	17	19		4681,6	9,3459
1086-1244	86	16000,00 (1600,00)	20000,00 (2000,00)	120	20,00	32,50	127,5	30,00	37,52	3	5	5,00	1600,0	3,9398
1086-1245							160,0	40,00	50,00	4	6		1920,0	4,7292
1086-1246							192,5	50,00	62,50	5	7		2240,0	5,5125
1086-1247							225,0	60,00	74,99	6	8		2560,0	6,3012
1086-1248							290,0	80,00	100,00	8	10		3200,0	7,8838
1086-1249							355,0	100,00	125,00	10	12		3840,0	9,4625
1086-1251							420,0	120,00	150,00	12	14		4480,0	11,0345
1086-1252							485,0	140,00	175,00	14	16		5120,0	12,6122
1086-1253	104	20000,00 (2000,00)	25000,00 (2500,00)	125	22,00	33,66	134,0	28,00	34,98	3	5	5,50	1648,0	4,9024
1086-1254							167,6	37,32	46,64	4	6		1977,6	5,8853
1086-1255							201,3	46,65	58,30	5	7		2307,2	6,8746
1086-1256							235,0	55,98	69,96	6	8		2636,8	7,8589
1086-1257							268,6	65,31	81,62	7	9		2966,4	8,8426
1086-1258							302,3	74,64	93,28	8	10		3296,0	9,8219
1086-1259							369,6	93,30	116,60	10	12		3955,2	11,7896
1086-1261							436,9	111,96	139,92	12	14		4614,4	13,7628
1086-1262							504,2	130,62	163,24	14	16		5273,6	15,7252
1086-1263							571,6	149,28	186,56	16	18		5932,8	17,6927
1086-1264	117	24000,00 (2400,00)	30000,00 (3000,00)	150	25,00	40,00	157,5	36,00	44,99	3	5	6,25	2000,0	7,6843
1086-1265							197,5	48,00	60,00	4	6		2400,0	9,2333



ИЗГОТОВЛЕНИЕ ПРУЖИН
ПОД ЗАКАЗ ПО ЧЕРТЕЖАМ

Телефон: +7(863)241-16-86

Email: dtm06@yandex.ru

Сайт: dtm06.ru

1086-1266									237,5	60,00	75,00	5	7		2800,0	11,2333
1086-1267									277,5	72,00	90,00	6	8		3200,0	12,3123
1086-1268									317,5	84,00	105,00	7	9		3600,0	13,8533
1086-1269									357,5	96,00	120,00	8	10		4000,0	15,3943
1086-1271									437,5	120,00	150,00	10	12		4800,0	18,4743
1086-1272									517,5	144,00	179,99	12	14		5600,0	22,5633
1086-1273									597,5	168,00	209,99	14	16		6400,0	24,6433
1086-1274									677,5	192,00	240,00	16	18		7200,0	29,9323
1086-1275		184	60000,00 (6000,00)	75000,00 (7500,00)	180	36,00	49,33	202,0	32,00	40,00	3	5	9,00	2304,0	18,3653	
1086-1276								251,3	42,64	53,33	4	6		2764,8	21,9924	
1086-1277								300,7	53,30	66,66	5	7		3225,6	25,7289	
1086-1278								350,0	63,96	80,00	6	8		3686,4	29,4106	
1086-1279								399,3	74,62	93,33	7	9		4147,2	33,0923	
1086-1281								448,6	85,28	106,66	8	10		4608,0	36,7746	
1086-1282								547,3	106,60	133,33	10	12		5529,6	44,1378	
1086-1283								646,0	127,92	160,00	12	14		6451,2	51,5014	
1086-1284								744,6	149,24	186,66	14	16		7372,8	58,8570	
1086-1285								843,3	170,56	213,33	16	18		8294,4	66,2286	
1086-1286		194	71000,00 (7100,00)	90000,00 (9000,00)	210	40,00	57,27	231,8	40,86	51,82	3	5	10,00	2720,0	26,7689	
1086-1287								289,0	54,48	69,09	4	6		3264,0	32,1363	
1086-1288								346,4	68,10	86,37	5	7		3808,0	37,5075	
1086-1289								403,6	81,72	103,65	6	8		4352,0	42,8686	
1086-1291								460,9	95,34	120,92	7	9		4896,0	48,2352	
1086-1292								518,2	108,96	138,19	8	10		5440,0	53,1572	
1086-1293								632,7	136,20	172,74	10	12		6528,0	64,3348	
1086-1294								747,2	163,44	207,29	12	14		7616,0	75,0735	
1086-1295								861,8	190,68	241,84	14	16		8704,0	85,8011	
1086-1296								976,3	217,92	276,39	16	18		9792,0	96,5397	

* F_3 - деформация при соприкосновении витков, применять при ударных нагрузках не рекомендуется.

Пример условного обозначения пружины размерами $D = 3$ мм, $H_0 = 5,8$ мм:

Пружина 1086-0751 ГОСТ 18793-80

2. Направление навивки правое (при применении сдвоенных пружин внутренняя пружина должна иметь левую навивку).
3. Технические требования - по ГОСТ 16118-70.
4. Маркировать на бирке: условное обозначение пружины без наименования и товарный знак предприятия-изготовителя.
5. Пример применения пружин сжатия, штырей для пружин и рекомендуемые диаметры отверстий под пружины сжатия даны в рекомендуемом приложении 1.
6. Графики усилий пружин сжатия в зависимости от их нагружения даны в справочном приложении 2.

ПРИЛОЖЕНИЕ 1
 Рекомендуемое

ПРИМЕР ПРИМЕНЕНИЯ ПРУЖИН СЖАТИЯ, ШТЫРЕЙ ДЛЯ ПРУЖИН И РЕКОМЕНДУЕМЫЕ ДИАМЕТРЫ ОТВЕРСТИЙ ПОД ПРУЖИНЫ СЖАТИЯ

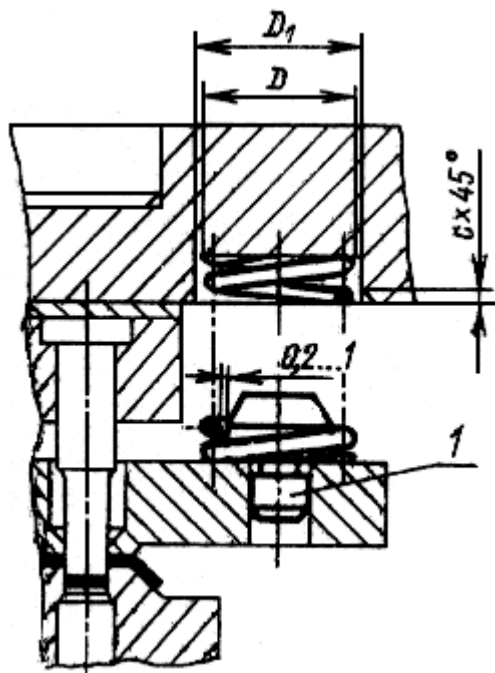

1 - штырь для пружин по ГОСТ 18798-80

мм

D	D_1	c
3	4	0,6
4	5	



ИЗГОТОВЛЕНИЕ ПРУЖИН
ПОД ЗАКАЗ ПО ЧЕРТЕЖАМ

Телефон: +7(863)241-16-86

Email: dtm06@yandex.ru

Сайт: dtm06.ru

5	6	
6	7	
8	9	
10	11	
11	13	1,0
12	14	
15	17	
16	18	
18	20	
20	22	
22	24	
24	26	
25	28	
28	30	
30	33	1,6
32	35	
34	37	
36	39	
38	42	
42	46	
45	50	
48	52	
50	55	
52	56	
55	60	
60	65	2,0
63	67	
70	75	
80	85	
85	90	



СПЛАВ
ИЗГОТОВЛЕНИЕ ПРУЖИН
ПОД ЗАКАЗ ПО ЧЕРТЕЖАМ

Телефон: +7(863)241-16-86

Email: dtm06@yandex.ru

Сайт: dtm06.ru

90	95	
95	100	
100	106	2,5
120	126	
125	131	
150	156	
180	186	
210	216	

ПРИЛОЖЕНИЕ 2
Справочное

ГРАФИКИ УСИЛИЙ ПРУЖИН СЖАТИЯ В ЗАВИСИМОСТИ ОТ ИХ НАГРУЖЕНИЯ (в кгс)



ИЗГОТОВЛЕНИЕ ПРУЖИН
ПОД ЗАКАЗ ПО ЧЕРТЕЖАМ

Телефон: +7(863)241-16-86

Email: dtm06@yandex.ru

Сайт: dtm06.ru

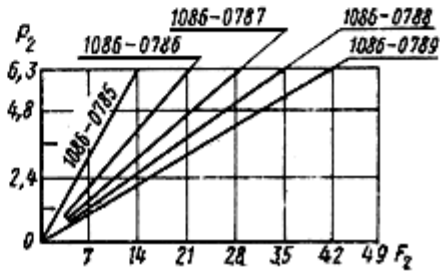
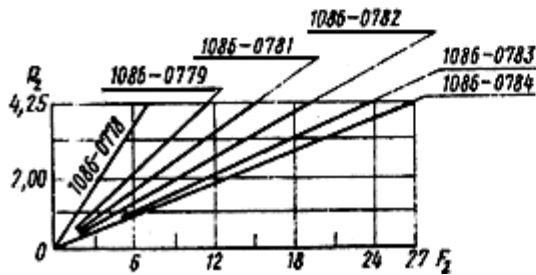
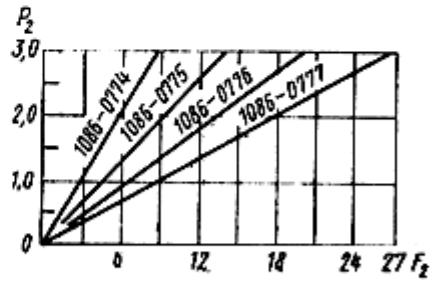
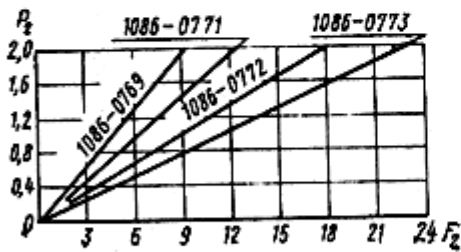
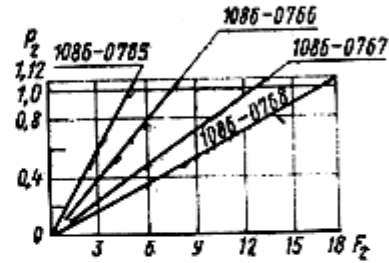
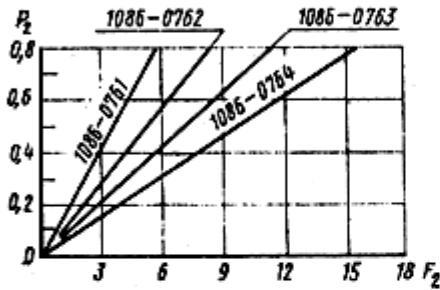
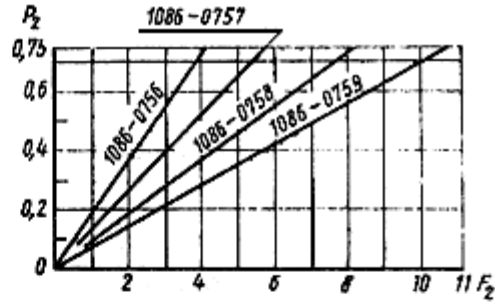
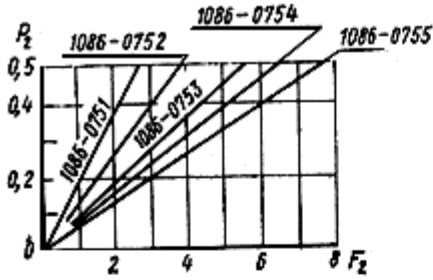



ИЗГОТОВЛЕНИЕ ПРУЖИН
ПОД ЗАКАЗ ПО ЧЕРТЕЖАМ

Телефон: +7(863)241-16-86

Email: dtm06@yandex.ru

Сайт: dtm06.ru

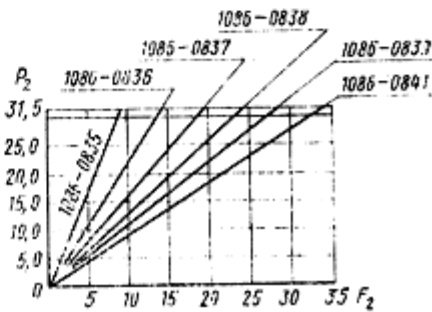
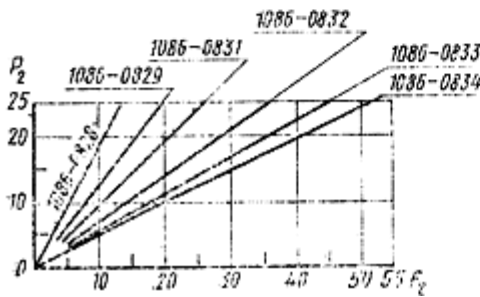
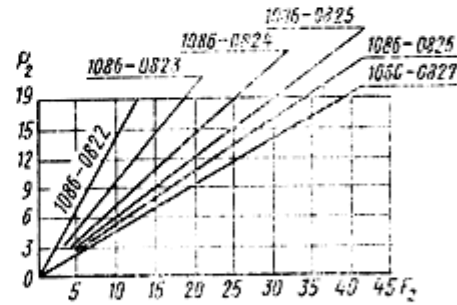
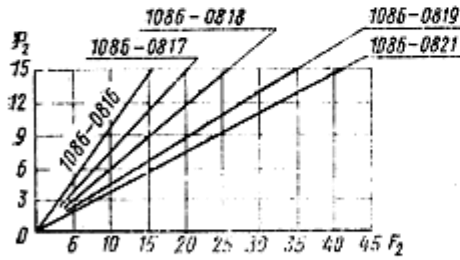
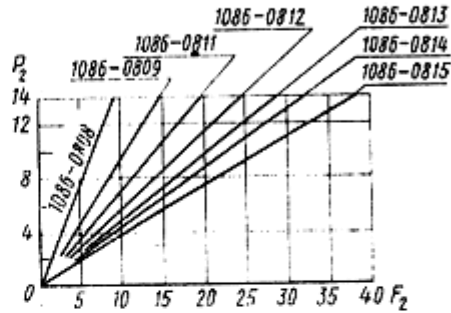
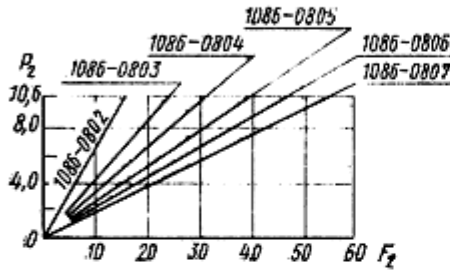
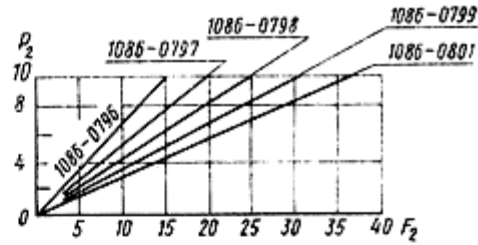
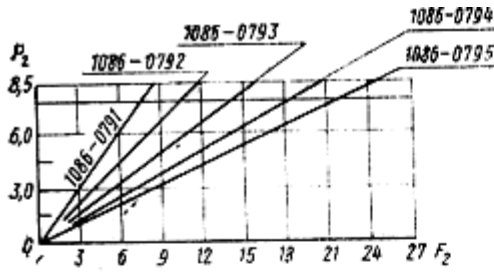



ИЗГОТОВЛЕНИЕ ПРУЖИН
ПОД ЗАКАЗ ПО ЧЕРТЕЖАМ

Телефон: +7(863)241-16-86

Email: dtm06@yandex.ru

Сайт: dtm06.ru

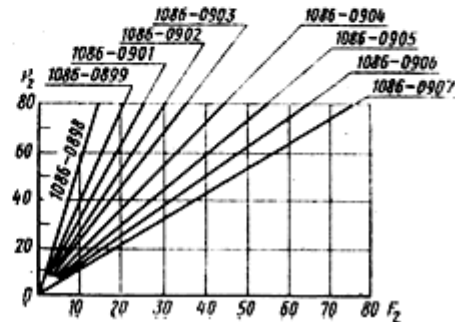
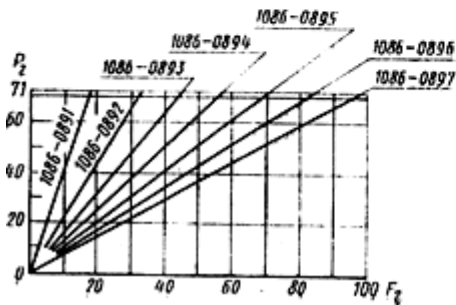
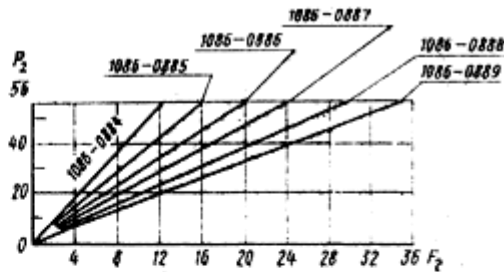
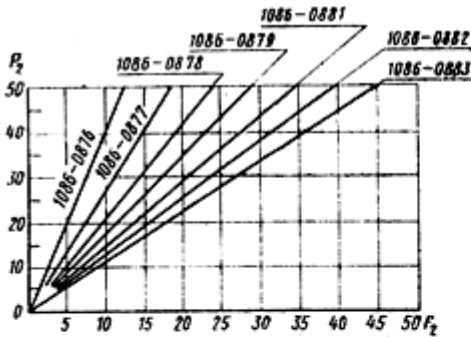
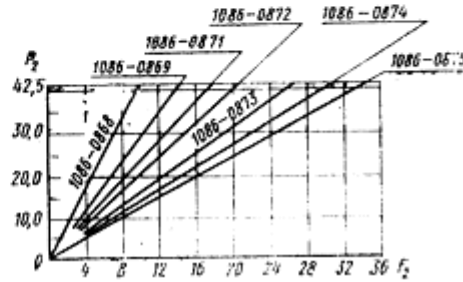
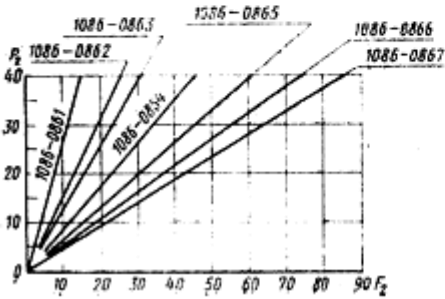
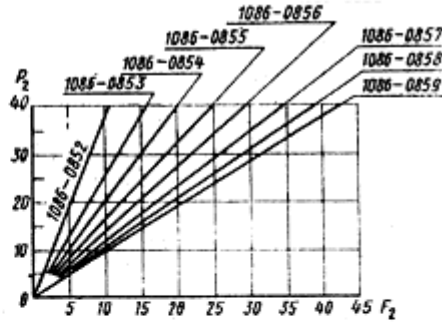
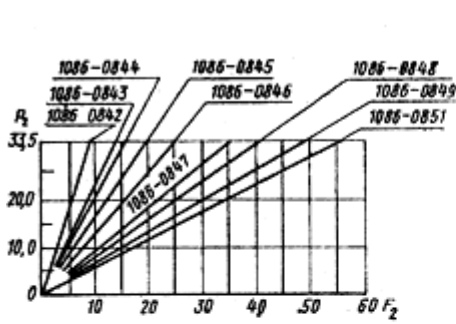



ИЗГОТОВЛЕНИЕ ПРУЖИН
ПОД ЗАКАЗ ПО ЧЕРТЕЖАМ

Телефон: +7(863)241-16-86

Email: dtm06@yandex.ru

Сайт: dtm06.ru

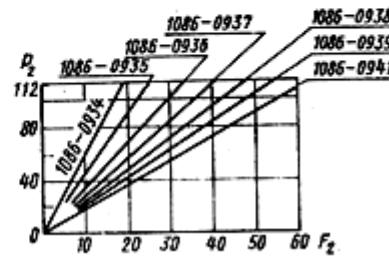
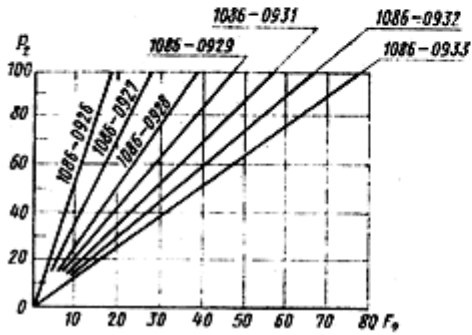
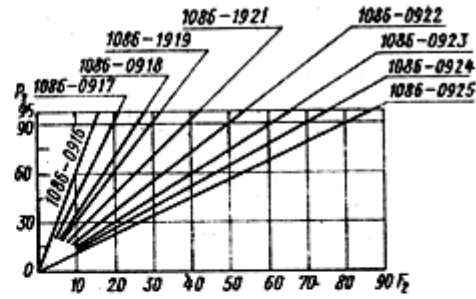
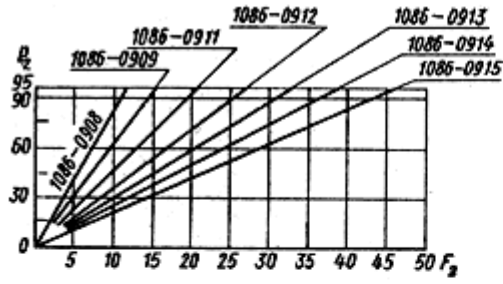



ИЗГОТОВЛЕНИЕ ПРУЖИН
ПОД ЗАКАЗ ПО ЧЕРТЕЖАМ

Телефон: +7(863)241-16-86

Email: dtm06@yandex.ru

Сайт: dtm06.ru

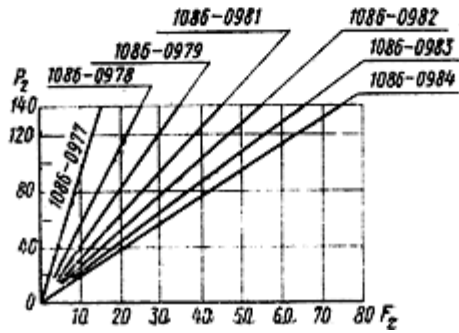
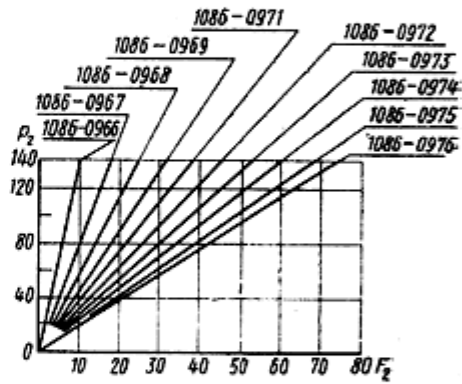
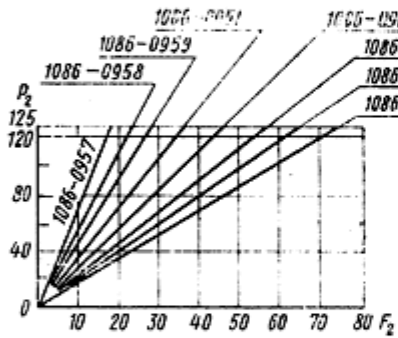
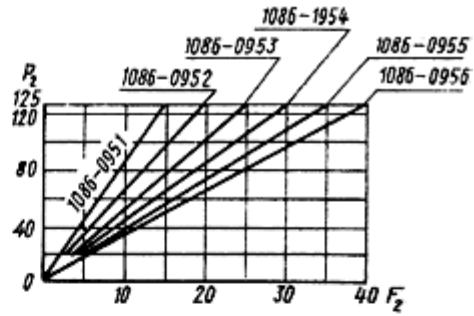
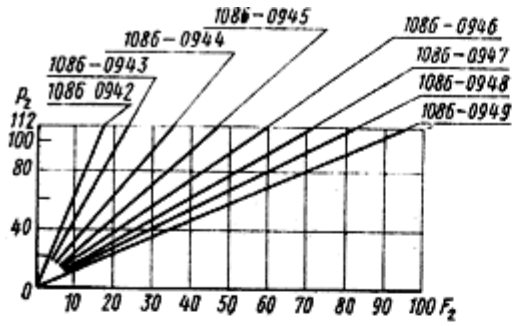



ИЗГОТОВЛЕНИЕ ПРУЖИН
ПОД ЗАКАЗ ПО ЧЕРТЕЖАМ

Телефон: +7(863)241-16-86

Email: dtm06@yandex.ru

Сайт: dtm06.ru

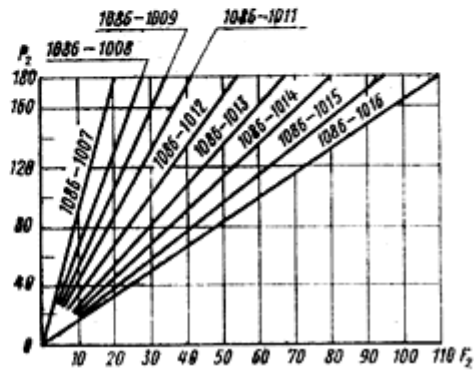
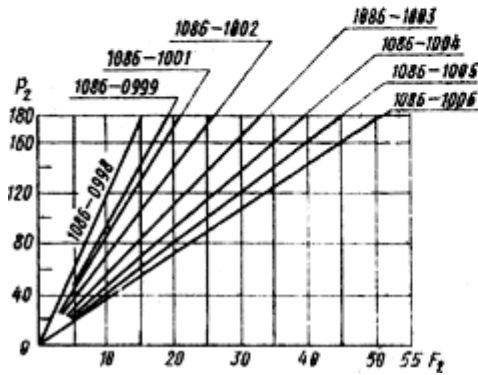
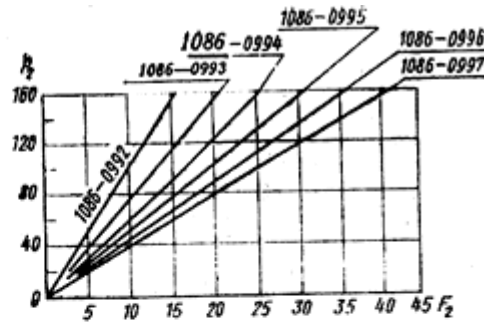
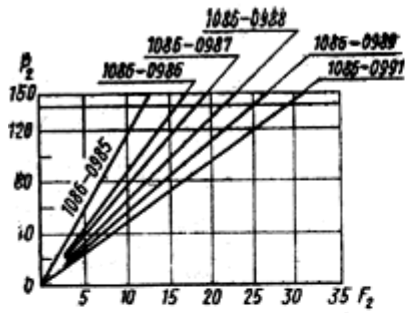



ИЗГОТОВЛЕНИЕ ПРУЖИН
ПОД ЗАКАЗ ПО ЧЕРТЕЖАМ

Телефон: +7(863)241-16-86

Email: dtm06@yandex.ru

Сайт: dtm06.ru

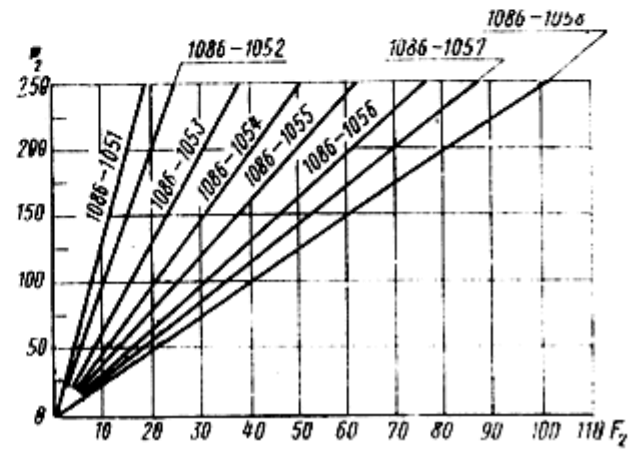
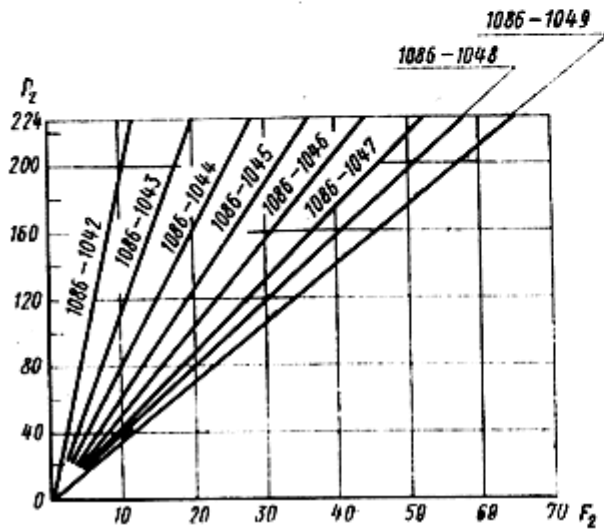
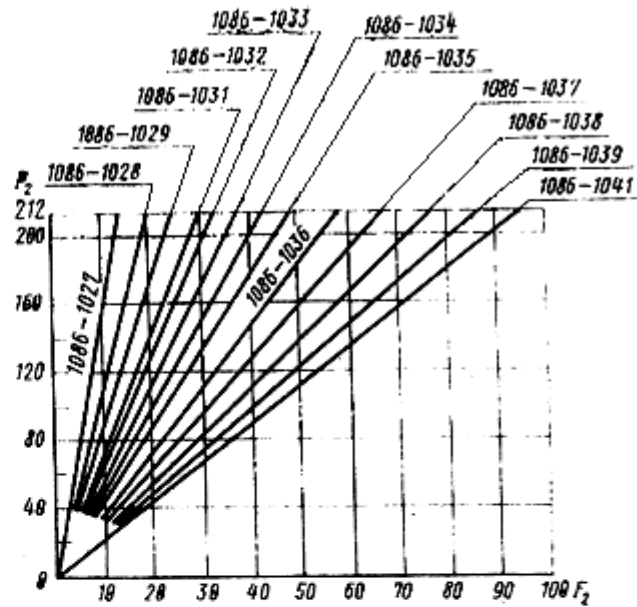
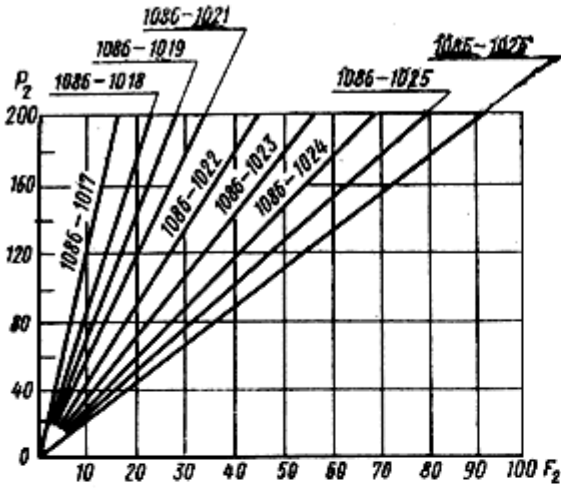



ИЗГОТОВЛЕНИЕ ПРУЖИН
ПОД ЗАКАЗ ПО ЧЕРТЕЖАМ

Телефон: +7(863)241-16-86

Email: dtm06@yandex.ru

Сайт: dtm06.ru

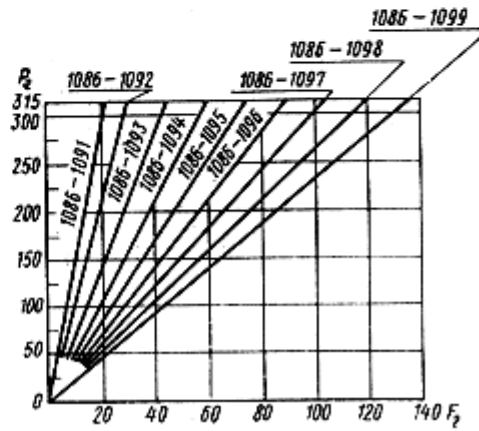
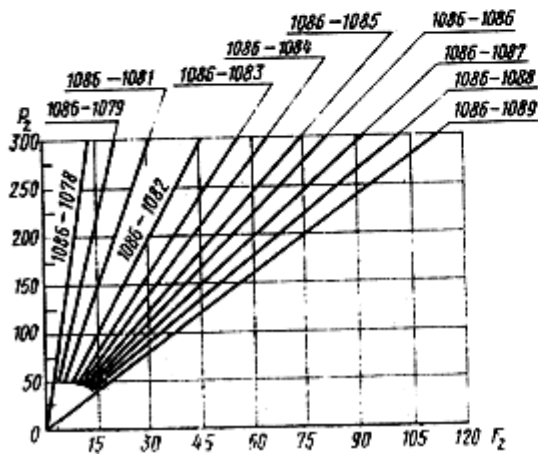
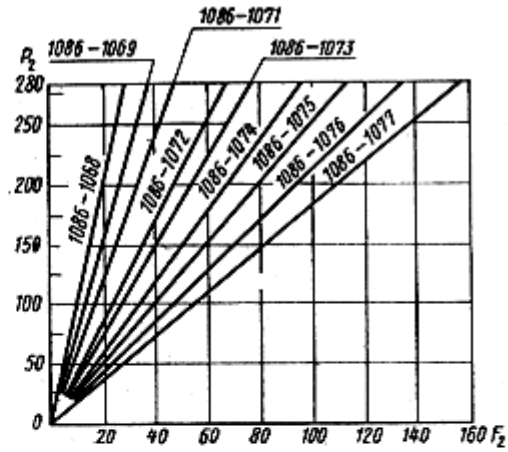
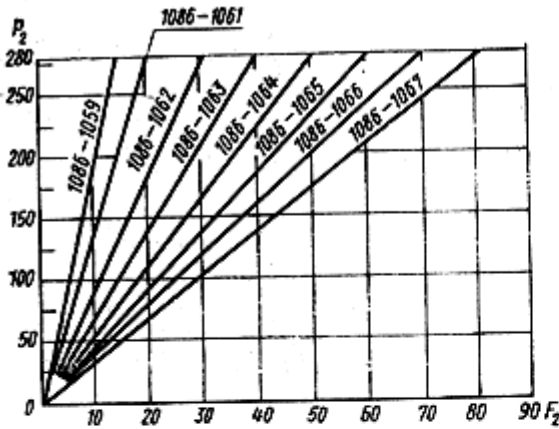



ИЗГОТОВЛЕНИЕ ПРУЖИН
ПОД ЗАКАЗ ПО ЧЕРТЕЖАМ

Телефон: +7(863)241-16-86

Email: dtm06@yandex.ru

Сайт: dtm06.ru

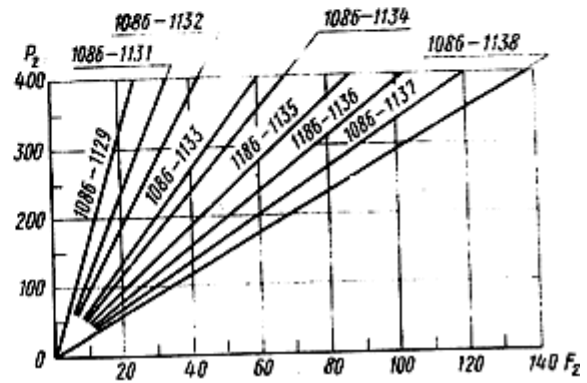
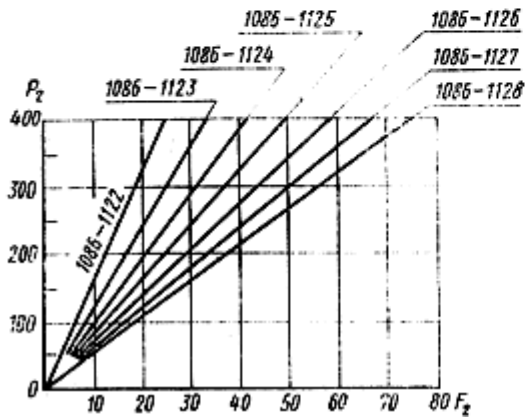
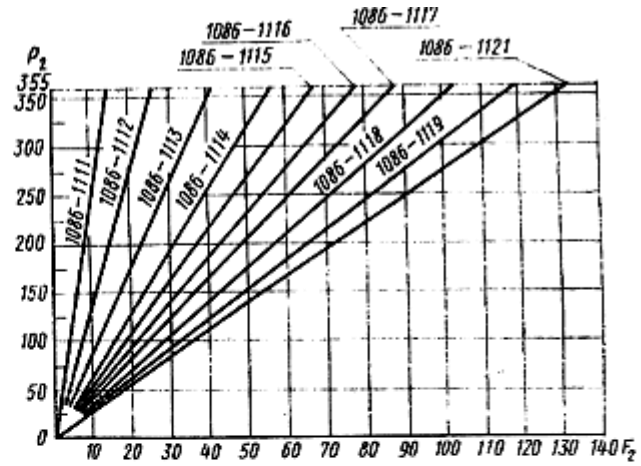
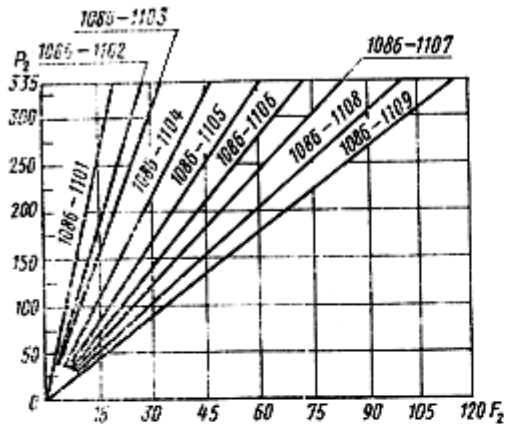



ИЗГОТОВЛЕНИЕ ПРУЖИН
ПОД ЗАКАЗ ПО ЧЕРТЕЖАМ

Телефон: +7(863)241-16-86

Email: dtm06@yandex.ru

Сайт: dtm06.ru

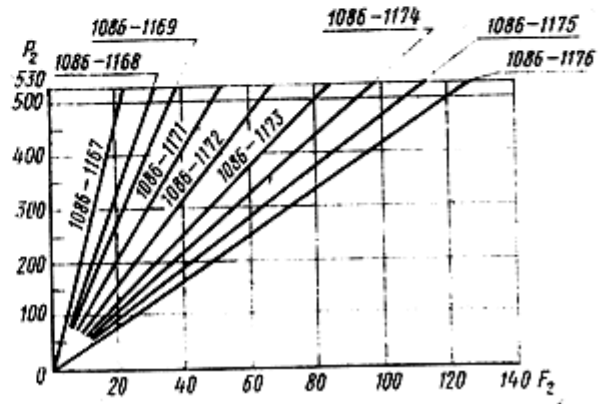
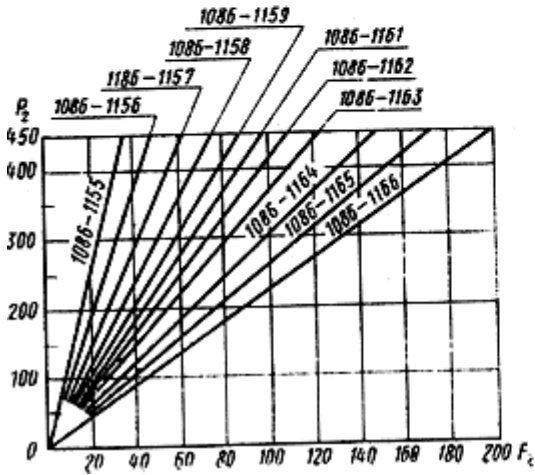
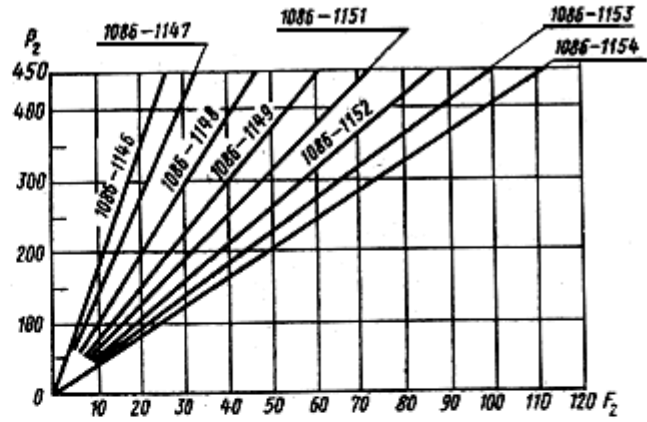
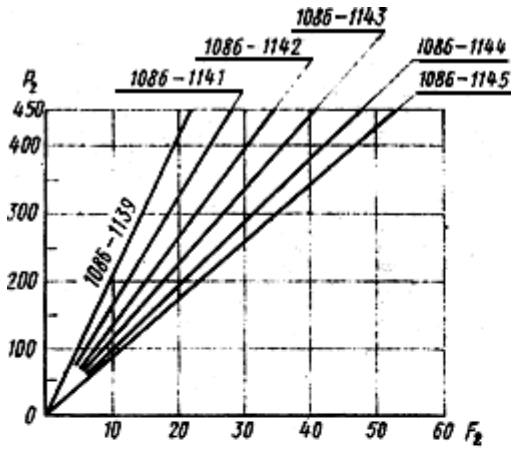



ИЗГОТОВЛЕНИЕ ПРУЖИН
ПОД ЗАКАЗ ПО ЧЕРТЕЖАМ

Телефон: +7(863)241-16-86

Email: dtm06@yandex.ru

Сайт: dtm06.ru

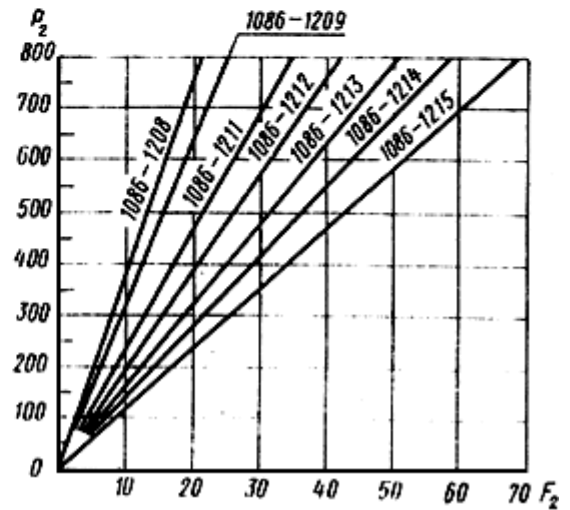
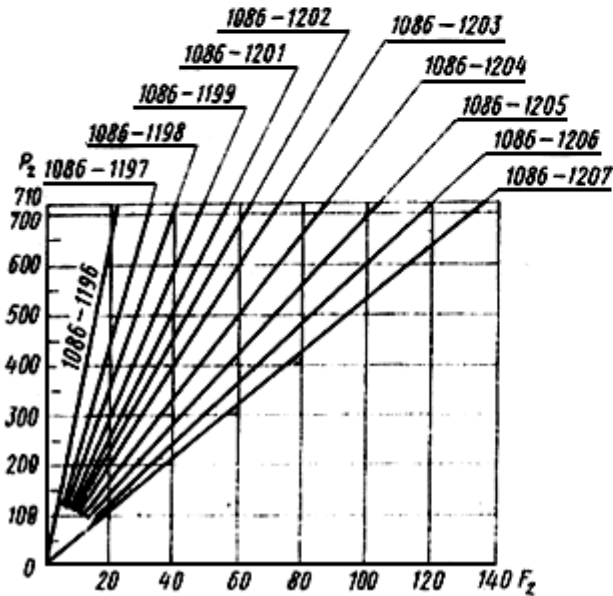
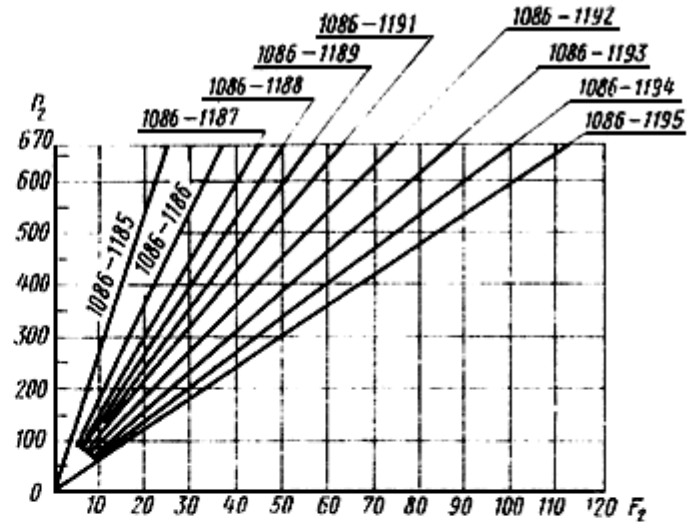
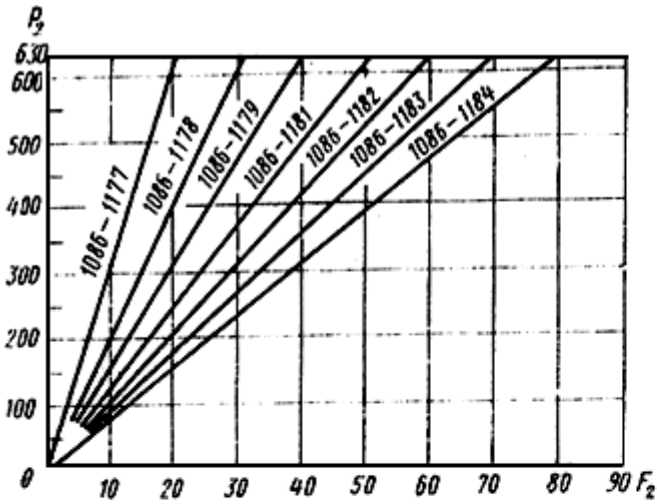



ИЗГОТОВЛЕНИЕ ПРУЖИН
ПОД ЗАКАЗ ПО ЧЕРТЕЖАМ

Телефон: +7(863)241-16-86

Email: dtm06@yandex.ru

Сайт: dtm06.ru

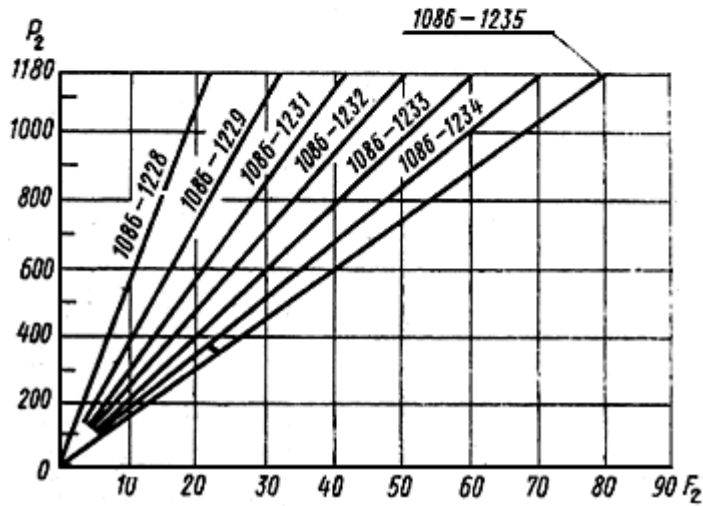
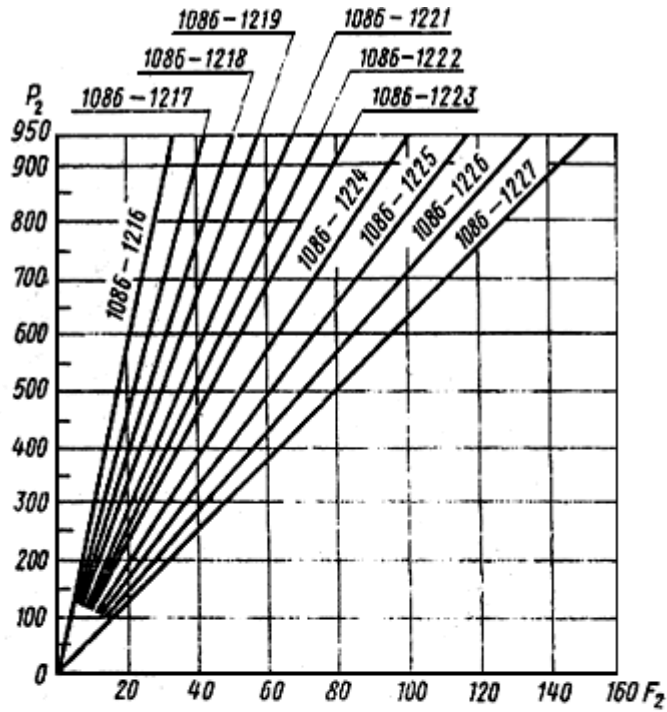



ИЗГОТОВЛЕНИЕ ПРУЖИН
ПОД ЗАКАЗ ПО ЧЕРТЕЖАМ

Телефон: +7(863)241-16-86

Email: dtm06@yandex.ru

Сайт: dtm06.ru

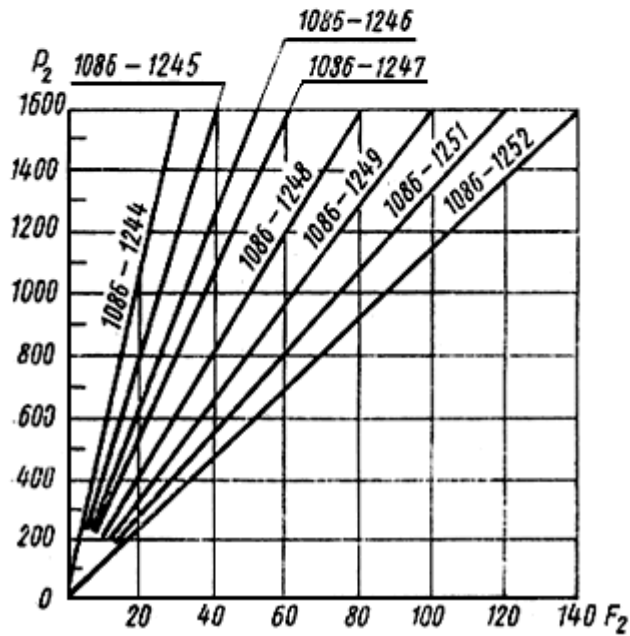
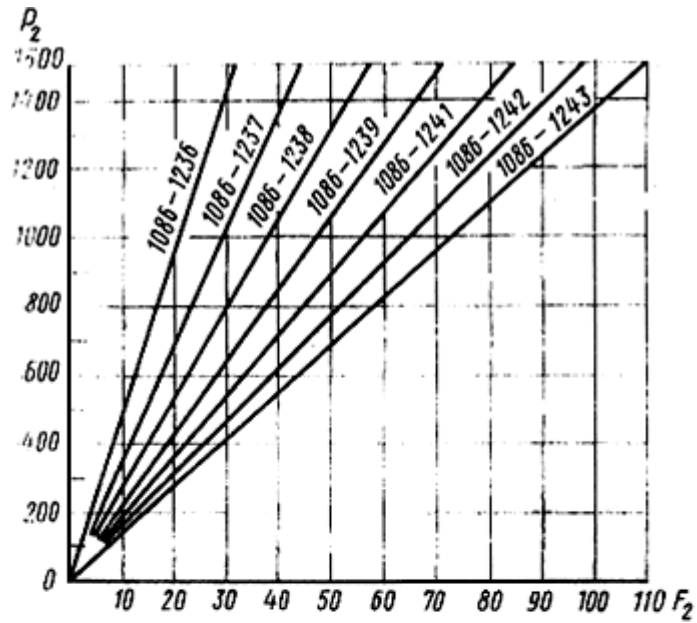



ИЗГОТОВЛЕНИЕ ПРУЖИН
ПОД ЗАКАЗ ПО ЧЕРТЕЖАМ

Телефон: +7(863)241-16-86

Email: dtm06@yandex.ru

Сайт: dtm06.ru

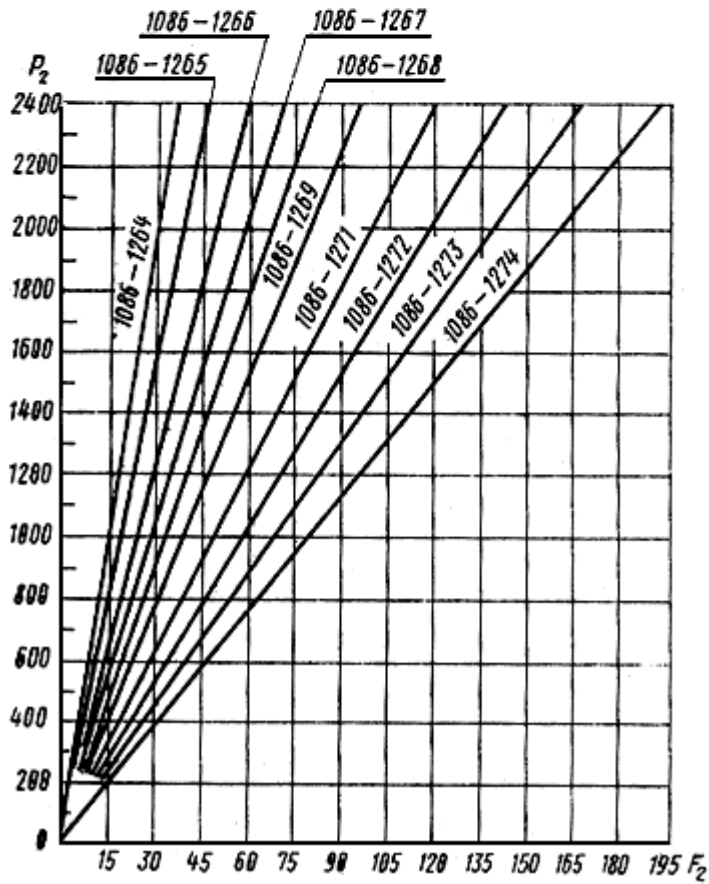
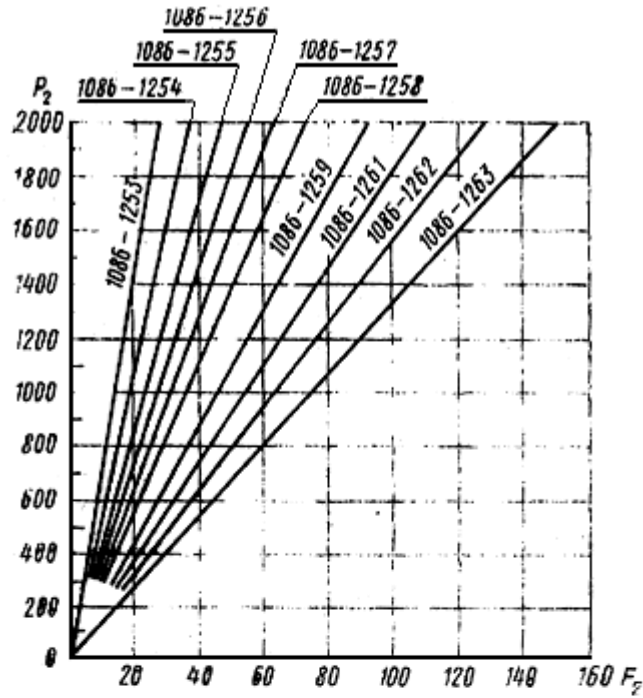



ИЗГОТОВЛЕНИЕ ПРУЖИН
ПОД ЗАКАЗ ПО ЧЕРТЕЖАМ

Телефон: +7(863)241-16-86

Email: dtm06@yandex.ru

Сайт: dtm06.ru

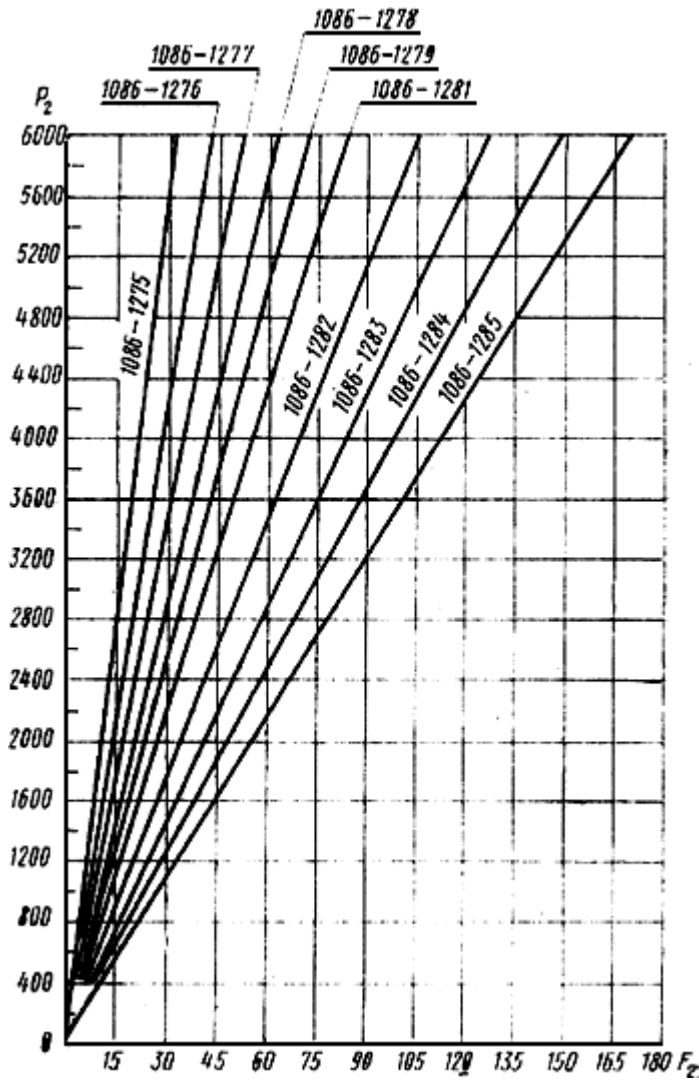



ИЗГОТОВЛЕНИЕ ПРУЖИН
ПОД ЗАКАЗ ПО ЧЕРТЕЖАМ

Телефон: +7(863)241-16-86

Email: dtm06@yandex.ru

Сайт: dtm06.ru

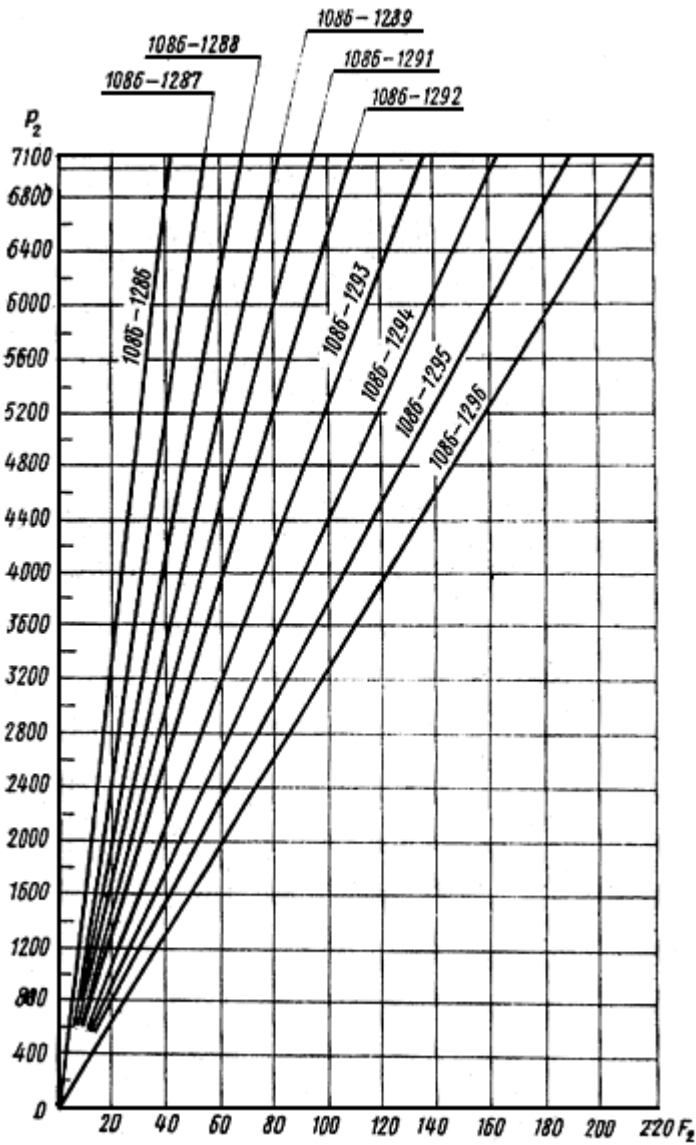

Текст документа сверен по:
официальное издание
Штампы листовой штамповки.
Детали и сборочные единицы:
Сб. ГОСТов. - М.: Издательство стандартов, 1987